

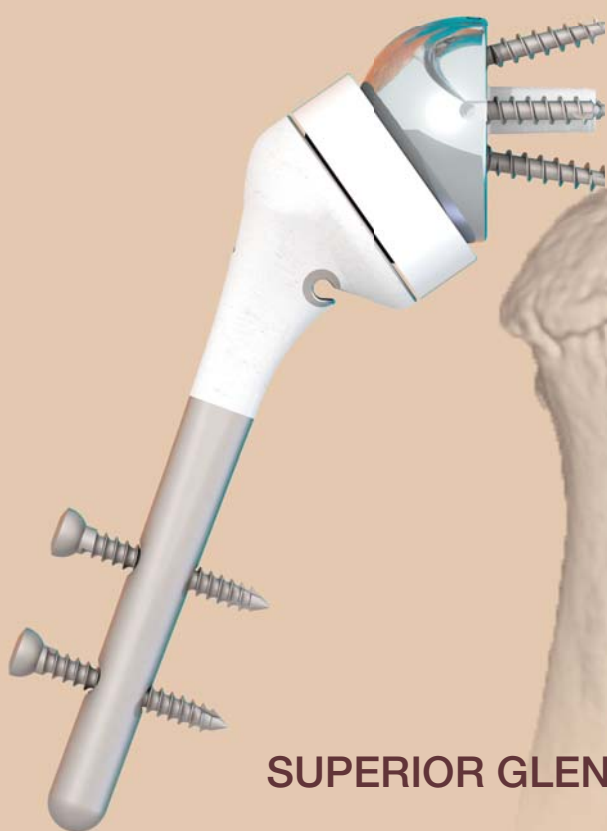

HUMELOCK™

REVERSED

Cementless



SUPERIOR GLENOID WEAR
PRIMARY, REVISION & TRAUMA



SURGICAL TECHNIQUE

CONTENTS

- Device description	page 03
- Intended use / Indications	page 05
- Warnings and precautions	page 05
- Trial materials	page 05
- Patient positioning	page 05
- Elective surgical technique - humerus (1)	page 06
- Surgical technique - glenoid	page 08
- Elective surgical technique - humerus (2)	page 10
- Trial implants	page 11
- Definitive implants	page 12
- Rehabilitation	page 13
- Trauma surgical technique - humerus (1)	page 14
- Surgical technique - glenoid	page 15
- Trauma surgical technique - humerus (2)	page 17
- Trial implants	page 19
- Definitive implants	page 20
- Rehabilitation	page 21
- Hemi-prosthesis technique	page 22
- Implant removal	page 23

PROPERTIES

Humelock™ Reversed is a new generation of reversed prosthesis, designed for numerous shoulder pathologies: ranging from superior glenoid wear to a complex cephalotuberosity fracture in a subject over 70 years. The technical characteristics of this implant have been designed based on computer simulations, correlated to results previously published in medical journals, in order to avoid the disadvantages of traditional reversed prostheses.

A centered or eccentric glenosphere, tilted at 10°, is centered on a variable length baseplate post (compatible with positioning techniques), the position of which is guided by intuitive adaptive instrumentation.

A 145° prosthetic epiphysis allows the pillar of the scapula to be protected while maintaining optimum stability.

The humeral implant is positioned naturally in the center of the metaphysis, preserving the remaining bone as much as possible.

The option of locking allows the surgeon to position the prosthetic stem at the required height, according to the patient's indication and anatomy.

Humelock™ Reversed is a totally modern implant, designed to adapt to the new lifestyles of older, increasingly active, patients for a longer timeframe.

DEVICE DESCRIPTION



The Humelock Reversed Shoulder is a total shoulder prosthesis designed for use in patients with a non-functional rotator cuff. The articulation of this design is inverted compared to a traditional total shoulder prosthesis. The reverse shoulder is designed so that the ball of the articulation is on the glenoid side and the mating cup fits into the humeral stem. The components of the system include a glenoid baseplate, standard and locking bone screws, optional baseplate post extensions, centered and eccentric glenospheres with and without central screws, humeral cups, cementless and cemented humeral stems, an optional humeral spacer, an optional anti-rotation spoiler and an optional taper adapter for use in hemi-shoulder replacement.

The Humelock glenoid baseplate has a round base with a central, cannulated post and four peripheral, threaded screw holes. The outer edges of the baseplate are tapered to lock with the glenosphere component.

The glenoid baseplate is used with 4.5mm standard or locking bone screws for added stability. The bone screws are available in lengths from 20 – 50mm in 5mm increments.

Optional post extensions are available to extend the central post of the baseplate and provide additional anchoring in cases with poor bone quality. The post extensions are available in 6mm and 10mm lengths. When used, the post extensions screw into the baseplate post.

The glenoid baseplate, standard and locking screws, and post extensions are manufactured from Ti-6Al-4V alloy conforming to ISO 5832-3. The backside of the baseplate and the post extensions are coated with a plasma sprayed CP Titanium and Hydroxyapatite coating.

The Humelock Reversed Glenosphere is available in 36 and 40 mm diameter sizes in centered and eccentric styles. The eccentric glenospheres are designed to be offset from the center of the glenoid baseplate. All glenospheres have a 10° tilt. Although not physically tilted, the curvature of the glenosphere extends 10° beyond the equator of a hemisphere. This additional articular surface lateralizes the center of rotation to help reduce the potential for scapular notching by the humeral cup. All glenospheres mate with the glenoid baseplate via a taper lock; the glenosphere incorporates a female taper while the edges of the baseplate form a male taper. The glenospheres are also available with an optional central, cannulated screw. This screw can be threaded through the central post of the baseplate for additional security.

The glenospheres are manufactured from Co-Cr-Mo conforming to ISO 5832-12. The glenosphere screw is manufactured from Ti-6Al-4V conforming to ISO 5832-3.

The humeral cups are one-piece constructs consisting of a pre-assembled Ti-6Al-4V alloy shell and a UHMWPE insert. A 24mm diameter tapered post on the inferior surface of the shell locks into the female taper on the superior surface of the humeral stem. The humeral cups are available in 36mm and 40mm diameters and in standard and mobility styles. The standard cups offer a slightly deeper articular surface to provide additional constraint while the mobility cups are not as deep to provide slightly less constraint. The humeral cups are available in heights of +3mm, +6mm and +9mm.

If additional height of the humeral articulation is needed, a +9mm humeral spacer can be used between the humeral stem and the humeral cup. The +9mm humeral spacer adds 9mm of height resulting in construct heights of +12mm, +15mm and +18mm. The spacer has a 24mm male taper that mates with the humeral stem and a 24mm female taper that mates with the humeral cup.

The humeral cups are manufactured from Ti-6Al-4V alloy conforming to ISO 5832-3 and UHMWPE conforming to ISO 5834-1 and ISO 5834-2. The +9mm humeral spacers are manufactured from Ti-6Al-4V alloy conforming to ISO 5832-3.

The Humelock Reversed Shoulder includes both cementless and cemented humeral stems. The cementless humeral stems are available in diameters of 8 to 16 mm. The distal end is cylindrical with a grit blasted surface and two unthreaded screw holes oriented in the medial/lateral direction. Cortical bone screws are available in lengths from 18 – 40mm in 2mm increments. The proximal portion of the cementless humeral stem has a plasma sprayed CP Titanium and Hydroxyapatite coating.

Cemented stems are available in diameters of 6 to 14 mm. The distal end of the cemented humeral stem is trapezoidal with a polished surface. The cementless and cemented humeral stems incorporate a 24mm diameter female taper for attachment of compatible components. A recess in the proximal, medial stem is intended to facilitate use of sutures, if needed, for fixation of bone fragments or bone graft.

Both the cementless and cemented stems are compatible with an optional spoiler, which can be attached to the lateral side of the stem to provide additional resistance to rotation. The spoiler is fixed to either stem using an M6 hex screw.

The spoiler and hex screw are manufactured from Ti-6Al-4V alloy conforming to ISO 5832-3.

During primary or revision surgery, if the glenoid bone stock appears to be insufficient to bear the reversed glenoid components or the glenoid bone fractures during the procedure, the Humelock Reversed cementless and cemented stems can be used with a taper adapter and 50, 52 or 54mm eccentric humeral heads for conversion to an anatomic shoulder hemi-arthroplasty. The taper adapter has a 24mm male taper to mate with the humeral stem and a 10mm male taper to mate with the humeral head. The taper adapter is manufactured from Ti-6Al-4V alloy conforming to ISO 5832-3. The eccentric humeral heads are manufactured from wrought Co-Cr-Mo conforming to ISO 5832-12.



INTENDED USE / INDICATIONS

Indications:

The Humelock Reversed Shoulder is indicated for primary, fracture or revision total shoulder arthroplasty for the relief of pain and to improve function in patients with a massive and non-repairable rotator cuff tear.

The patient's joint must be anatomically and structurally suited to receive the selected implants and a functional deltoid muscle is necessary to use the device.

During primary or revision surgery, if the glenoid bone stock appears to be insufficient to bear the reversed glenoid components or the glenoid bone fractures during the procedure, a taper adapter can be used to convert the Humelock Reversed Shoulder to an anatomic hemi-shoulder prosthesis.

The humeral stem of the Humelock Reversed Cemented Shoulder Prosthesis is intended for cemented use only. The humeral stem of the Humelock Reversed Cementless Shoulder Prosthesis is lockable with two cortical bone screws and is intended for cementless use only. An optional anti-rotation spoiler can be used with either the cementless or the cemented stems.

The glenoid baseplate and post extension are intended for cementless use with the addition of screws for fixation.

Contraindications :

- Non-displaced or slightly displaced fractures.
- Dislocation fractures in elderly subjects.
- Acute, chronic, local or systemic infections.
- Severe muscular, neurological or vascular impairment affecting the joint in question.
- Bone destruction or poor bone quality that could compromise the stability of the device.
- Excessive alcohol consumption or other dependency disorders.
- Allergy to the material.
- Any concomitant illness that could compromise the function of the device.

WARNINGS AND PRECAUTIONS

Unless otherwise indicated, instrument sets are sold non-sterile and must be completely cleaned and sterilized before use.

Instruments must not undergo accelerated autoclave sterilization inside the instrument box.

Accelerated autoclave sterilization of individual instruments has not been validated by the manufacturer.

Please consult the instrument package insert for validated sterilization instructions and the implant package insert for a complete list of warnings, precautions, contraindications and adverse events.

TRIAL MATERIALS

The trial implants are manufactured from Radel polyphenylsulfone (PPSU) which meets the requirements of USP Class VI; Polypropylene (PP) which meets the requirements of USP Class VI and Ti-6Al-4V conforming to ISO 5832-3.

The colorants used in the glenosphere trials and reversed cup trials are Ensinger light lime, green and bone. The colorant used in the trial humeral spacer +09 mm is O'Neil orange.

The colorant used in the trial eccentric taper adapter Ø24/Ø10 is O'Neil orange.

PATIENT POSITIONING

The recommended patient positioning is a beach chair with a member free in the operating area and the head fixed in position.

X-ray imaging must be available to confirm implant position intraoperatively.

ELECTIVE SURG. TECH. - HUMERUS (1)

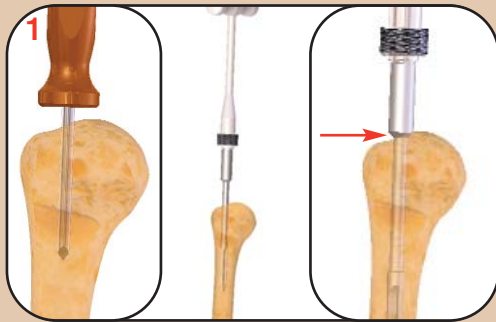

Preparation of the humeral shaft:

Locate and perforate the top of the humeral head in the medullary canal axis using a triangular awl.

Use the reamers in increasing size order on the T handle.

Go from one size to the next until the diameter of the reamer meets the diameter of the shaft.

The reamer should enter the humeral shaft up to the guard (→).

The stem choice is made depending on the last reamer size used:

Ø08 mm --> Stem with an epiphysis of Ø32 mm;

Ø10 mm --> Stem with an epiphysis of Ø32 or 36 mm;

Ø12 mm --> Stem with an epiphysis of Ø32, 36 or 40 mm;

Ø14 mm --> Stem with an epiphysis of Ø36 or 40 mm;

Ø16 mm --> Stem with an epiphysis of Ø40 mm.

Mounting the delto-pectoral cutting guide:



Slide the cutting guide onto the remaining reamer.

Screw the retroversion stem into one of the 4 positions according to the required angle: 0, 10, 20, 30°.



Placing the 145° cutting guide:

The probe stops at the top of the head and determines the incision height.

The retroversion is determined by screwing the rod into one of 4 positions (0, 10, 20, 30°) and aligning it with the forearm axis.

Fastening the retroversion rod sets the position for the cutting guide.

Place two pins (A1+A2) by drilling if necessary, using the Ø3.2 mm bit.

Remove the retroversion rod and the reamer.
Slide the cutting guide along the pins.
Stabilize the mounting using a 3rd divergent pin (B).
Make the incision across the desired slot (0, +3 or +6) with a saw blade of a maximum 0.9 mm thickness.
Choose the slot in order to resect 1-2 mm of the proximal area of the greater tuberosity.





Mounting the superior-lateral cutting guide:



Slide the cutting guide onto the remaining reamer. Screw the retroversion stem into one of the 4 positions according to the required angle: 0°, 10°, 20°, 30°.

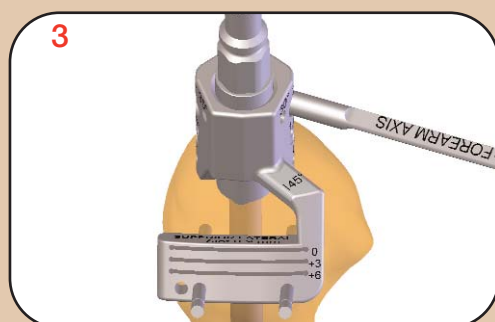

Placing the 145° cutting guide:

The probe stops at the top of the head and determines the incision height.

The retroversion is determined by screwing the rod into one of the 4 positions (0, 10, 20, 30°) and aligning it with the forearm axis. Fastening the retroversion rod sets the position for the cutting guide.



Remove the retroversion rod and the reamer.

Slide the cutting guide on the pins.

Make the incision across the desired slot (0, +3 or +6) with a saw blade of a maximum 0.9 mm thickness.

Choose the slot in order to resect 1-2 mm of the proximal area of the greater tuberosity.



Humerus protection:

Insert the protector into the prepared humerus during the glenoid preparation.

SURG. TECH. - GLENOID

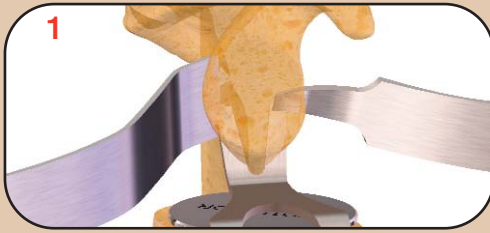

Glenoid exposure :

Expose the glenoid fully using the three types of retractors.

- Anterior retractor,
- Superior retractor,
- Inferior retractor.

Remove the glenoid labrum.

Remove any potential osteophytes to expose the full bone anatomy.

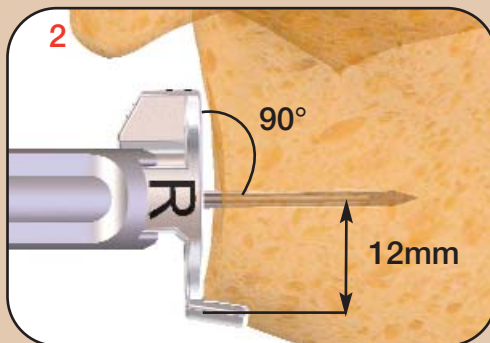

Placing the K-wire:

The three different positions for the guide are: Left (L), Right (R) for a deltopectoral approach and Superior lateral (S).

Position the K-wire guide on the inferior part of the glenoid to determine the correct height.

The K-wire is 12 mm above the lower edge, according to Kelly¹ and must be centered in the antero-posterior plane.

The K-wire guide orientation is important for the glenoid tilt and must be done at 90°-(see picture #2).

The glenospheres are tilted (lower lip) by 10°.

Positioning should be to fit the anatomy of the patient and planned according to the pre-operative X rays.

This element must be decided in pre-operative planning. By default, the base plate is perpendicular to the mid plane of the glenoid.

Insert the K-wire using a power tool.

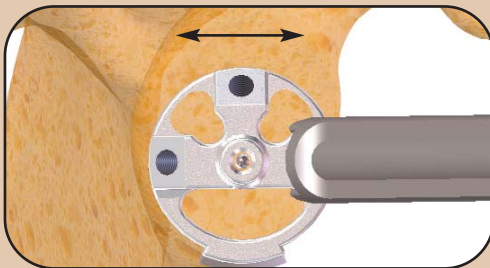

(1) Kelly JD, Humphrey CS, Norris TR. Optimizing glenosphere position and fixation in reverse shoulder arthroplasty, Part One: the twelve-mm rule. J Shoulder Elbow Surg 2008;17:589-94

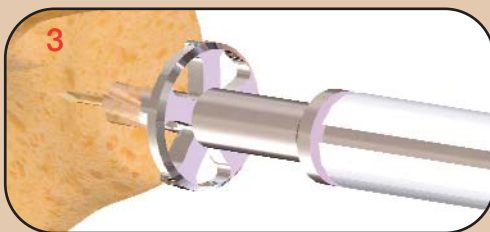

Glenoid reaming:

Drill and ream the glenoid using the K-wire as a guide.

Ream until the subchondral bone is reached.

This step can be done by power or by hand if the glenoid is porotic.

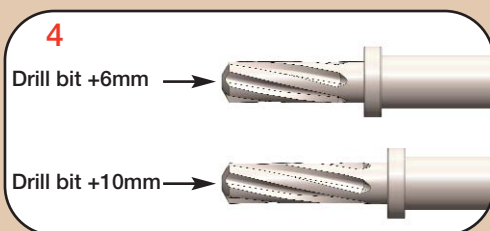

Extension post:

If bone graft is used between the glenoid baseplate and the native glenoid, the baseplate post can be extended by 6 or 10 mm as required. It is important to check that the tip of the extension is properly implanted in the native glenoid.

Drill the post again with the stop drill bit either +6 mm or +10 mm as required.

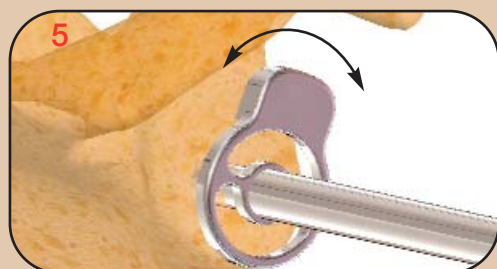

Glenoid clearance:

Remove the K-wire.

To avoid any interference between the glenosphere and the scapula, ream the glenoid using the Ø40 mm hand reamer.



Pay attention to avoid ovalizing the post hole.

360° clearance = successful impaction of the glenosphere.

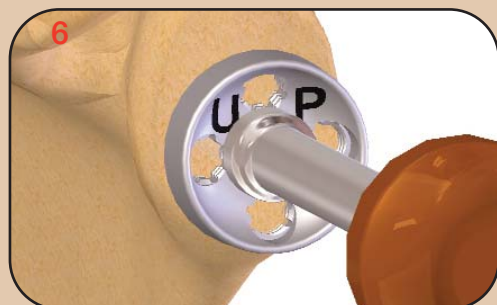

Positioning the baseplate: (Ø24 mm)

Connect the holder/impactor to the baseplate.

Impact the baseplate so that there is pressure on the whole surface. The impactor allows for the upper and lower holes to be placed so that a screw can be positioned in the base of the coracoid and in the pillar of the scapula.



The UP marking must be on top under the coracoid basis.

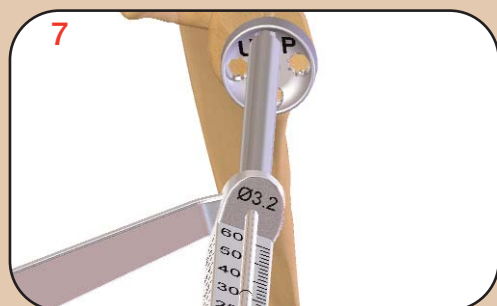

Length of screws (7 sizes from 20 to 50 mm) :

An adapted guide allows drilling and measuring the screws with the Ø 3.2 mm drill bit.

The length of the screws is measured directly.

The screw length is measured from under the head.

Two types of screws are available, locking or standard (compression).

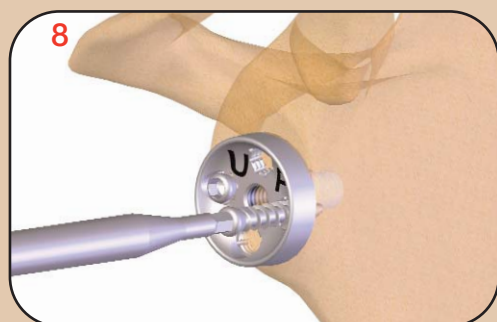

Fixation of the baseplate: (Ø24 mm)

Standard screws allow the baseplate to be lagged to the bone, and locking screws fix the mounting.

Each screw allows an angulation of +/-12° around the axial hole.

The upper hole is pre-oriented by 10° to optimize its positioning in the base of the coracoid.

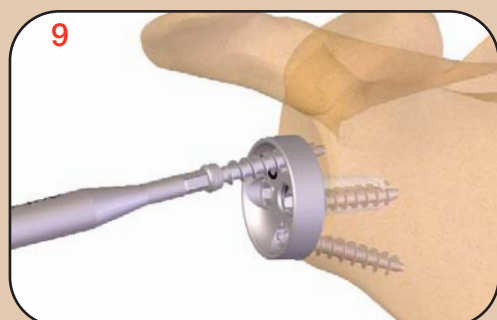

Recommendations:

2 compression screws (std) for anterior and posterior holes.

2 locking screws for superior and inferior holes.

ELECTIVE SURG. TECH. - HUMERUS (2)

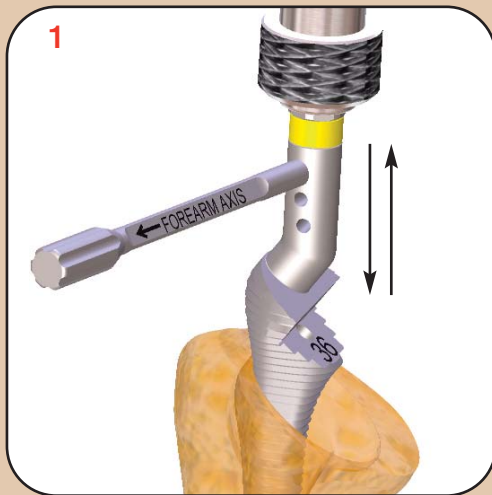

Metaphyseal preparation :

Use the metaphyseal rasps size by size while also checking the retroversion.

The size of the epiphysis is determined by the size of the last used rasp.

Ø8 mm --> Stem with an epiphysis of Ø32 mm;

Ø10 mm --> Stem with an epiphysis of Ø32 or 36 mm;

Ø12 mm --> Stem with an epiphysis of Ø32, 36 or 40 mm;

Ø14 mm --> Stem with an epiphysis of Ø36 mm or 40 mm;

Ø16 mm --> Stem with an epiphysis of Ø40 mm;

Connect the rasp to the T handle.

Screw the retroversion rod onto the rasp.

Impact the rasp until it is flush with the height of the resected bone surface.



Epiphyseal preparation (OPTION):

Use the same size of epiphyseal rasp as the metaphyseal rasp or not, according to bone density.

The metaphyseal and epiphyseal rasps are color coded.

Unfasten the inside part of the rasp and fit the epiphyseal rasp in the designated hole.

Maintain the metaphyseal rasp using the special wrench.

Shape the epiphysis up to the height of the metaphyseal rasp.

OPTION: SPOILER



Fitting the spoiler (OPTION) :

If additional anti-rotational assurance is desired, addition of a spoiler to the system is available as an option.

After choosing the appropriate stem, insert the spoiler into the slot on the lateral side of the stem.

Stem positioning:

Insert the stem impactor into the taper of the stem.

Check that the pin is correctly located in its housing within the stem.

Tighten the screw of the mounting «implants + stem impactor».

The retroversion is determined by screwing the rod into one of the 3 positions (0, 10, 20°) and aligning it with the arm.



Stem impactation:

Check the angulation of the retroversion rod while impacting the stem.

Secure the spoiler using the screw provided with the Hex 3.5 mm screwdriver through the top of the stem, passing through the hole in the spoiler and engaging with the internal threads of the screw hole in the stem.

Protect the stem and the humerus, with a protector, by placing it in the stem during the glenoid preparation.





TRIAL IMPLANTS

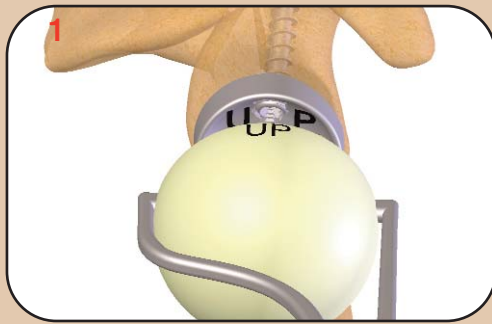

Glenosphere trial (10° tilt):

There are two diameters of glenospheres: Ø36 and 40 mm.
 All glenospheres are centered or eccentric with or without a screw.
 The choice of glenosphere does not depend on the size of the humeral stem.
 All glenospheres are tilted downwards by 10°.

Position the glenosphere with the special clamp allowing the humerus to be circumvented by the delto-pectoral approach.

The choice of the suitable glenoid implant depends on the stability of the shoulder:

Proceed with a trial reduction using a 36 mm diameter glenosphere trial implant.

- If tension of the conjoint tendon is substantially decreased by palpation, change from the 36 to the 40 mm diameter trial implant.
 - Perform longitudinal traction holding the arm in neutral position trying to detect maximum separation of the trial prosthetic surface. If this maneuver causes inferior subluxation change from the 36 to the 40 mm diameter trial implant.
 - External rotation may demonstrate a slight gapping (2 to 3 mm) between the glenosphere and the articular surface. If the gap is increased, change from the 36 to the 40 mm diameter trial implant.
 - If external and internal rotation cause early contact between the metaphyseal bone and the scapular pillar with a tendency to sublux, change from the 36 to the 40 mm diameter trial implant.
 - Perform forced adduction of the arm with your fist in the axilla as a fulcrum. This is supposed to cause a slight opening of the joint gap (not more than 2 to 3 mm) without lateral dislocation, otherwise change from the 36 to the 40 mm diameter trial implant.
 - Finally, assess stability at 90° of abduction with the humerus in external, neutral and internal rotation.
- If on the other hand reduction with the 40 mm diameter trial implant is impossible or very difficult, you will need to use the 36 mm diameter trial implant.



Reversed cup trial:

The cup diameter matches the glenosphere diameter.
 Three heights are available (+3, +6, +9 mm).

Choice of humeral cup:

The choice of humeral cup depends on the stability of the shoulder and the activity level of the patient:
 The Mobility Cup is a good option for active patients with good to

excellent stability and strength of the subscapularis and infraspinatus muscles.

The Standard Cup should be considered in less active patients with instability due to rotator cuff insufficiency. The choice of the Standard Reversed Humeral Cup or the Standard Reversed Humeral Cup plus Humeral Spacer +09 mm is based on the height needed for the humeral side of the joint reconstruction. Most patients can achieve adequate humeral height with the +3 mm, +6 mm or +9 mm options available with the Reversed Humeral Cup. The choice of height depends on the location of the humeral cut, the stability of the reconstruction, the tension of the deltoid muscle (based on palpation) and the activity level of the patient. In rare cases with significant metaphyseal bone resection (e.g. revisions, tumor resections), additional humeral height may be desired. In these cases, the Humeral Spacer +09 mm may be used with the Standard Humeral Cup to provide an additional 9 mm of height, resulting in humeral construct heights of +12 mm, +15 mm and +18 mm.



Take care to respect index marks on the stem and cup.

Test for stability and mobility. Trials are identical to final implants.

DEFINITIVE IMPLANTS

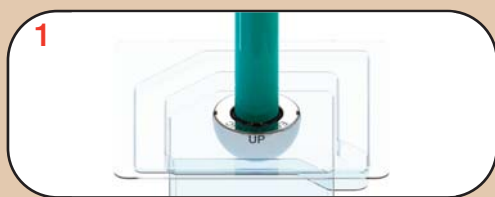

Handling of the definitive glenosphere:

Impacted glenosphere

Insert the glenosphere implant holder into the definitive implant. On the specially designed clamp, there are notches on the jaws which should be positioned to coincide with those on the middle of the glenosphere implant.



Handling of the definitive glenosphere w/screw:

Impacted glenosphere w/screw

Insert the 3.5mm hex screwdriver in the screw of the glenosphere.

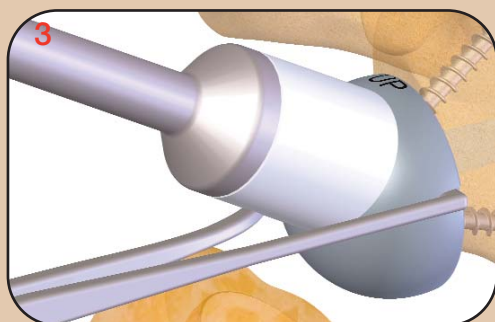

Fitting of the definitive implants:

Impacted glenosphere

When positioning the glenosphere, pay attention to the "UP" marking, if an eccentric glenosphere is used.

First introduce the guiding post, then the female taper of the glenosphere into the male taper of the baseplate.

Be sure to check that the baseplate is clean and free of any bone or tissue particles that could hinder impaction of the Morse taper.



Impact the glenosphere and check it before closure.



Fitting of the definitive implants:

Impacted glenosphere w/screw

Insert the glenosphere paying attention to the «UP» marking, if an eccentric glenosphere is used.

Introduce the screw of the glenosphere in the post of the baseplate.

Be sure to check that the baseplate is clean and free of any bone or tissue particles that could hinder impaction of the Morse taper.

- 1- Begin to screw the glenosphere w/screw.
- 2- Impact the glenosphere with the impactor.
- 3- Finish screwing



Do not impact the glenosphere with the screwdriver.



Index of the definitive reversed cup :

Find the index marks on both the definitive cup and the stem. Position the cup so that the index matches the index on the stem.

Insert the cup into the taper of the stem so that the indices of the cup and stem are correctly aligned.

Check that there is nothing impeding impaction of the cup and impact it.



If the neck of the scapula is short, it is recommended to use an offset glenosphere to reduce the risk of notching.

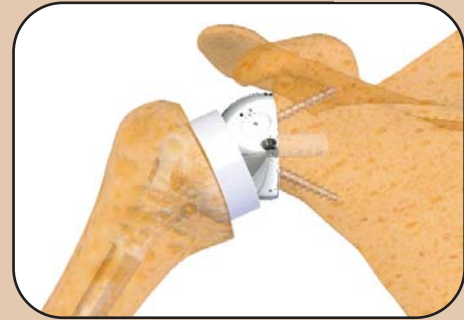

If the neck of the scapula is long, depending on the deltoid tension and the stability of the mounting, a centered glenosphere can be implanted.

REHABILITATION

Short-term immobilization (according to the surgeon's assessment) with mobilization in neutral rotation to promote recovery of external rotation.

Promote pool therapy and specialist rehabilitation, without counter-resistance work for six weeks, depending on the age and objectives noted in the "patient contract".

TRAUMA SURG. TECH. - HUMERUS (1)



Preparation of the humeral shaft:

Use the reamers in increasing size order on the T handle. Go from one size to the next until the diameter of the reamer meets the diameter of the shaft.

The stem choice is made depending on the last reamer size used:

- Ø08 mm --> Stem with an epiphysis of Ø32 mm;
- Ø10 mm --> Stem with an epiphysis of Ø32 or 36 mm;
- Ø12 mm --> Stem with an epiphysis of Ø32, 36 or 40 mm;
- Ø14 mm --> Stem with an epiphysis of Ø36 or 40 mm;
- Ø16 mm --> Stem with an epiphysis of Ø40 mm.

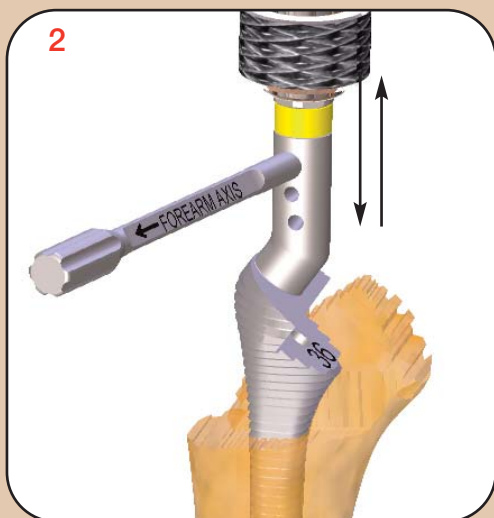

Metaphyseal preparation (OPTION):

Use the metaphyseal rasps size by size while also checking the retroversion.

The size of the metaphysis is determined by the size of the last used rasp.

- Ø08 mm --> Stem with an epiphysis of Ø32 mm;
- Ø10 mm --> Stem with an epiphysis of Ø32 or 36 mm;
- Ø12 mm --> Stem with an epiphysis of Ø32, 36 or 40 mm;
- Ø14 mm --> Stem with an epiphysis of Ø36 or 40 mm;
- Ø16 mm --> Stem with an epiphysis of Ø40 mm;

Connect the rasp to the T handle.

Screw the retroversion rod onto the rasp.

Impact the rasp until it is flush with the height of the resected bone surface.

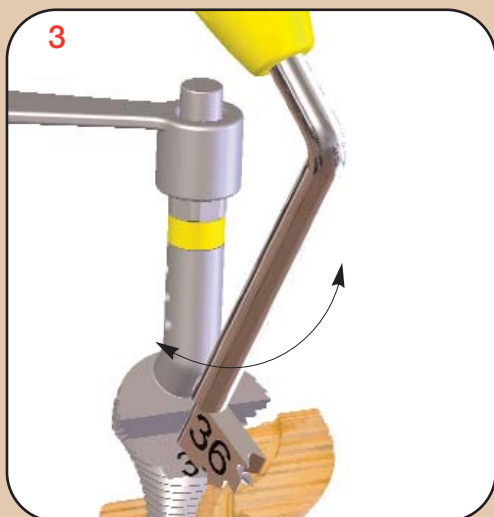

Epiphyseal preparation (OPTION):

Use the same size of epiphyseal rasp as the metaphyseal rasp. The metaphyseal and epiphyseal rasps are color coded.

Unfasten the inside part of the rasp and fit the epiphyseal rasp in the designated hole.

Maintain the metaphyseal rasp using the special wrench.

Shape the epiphysis up to the height of the metaphyseal rasp.



Humerus protection:

Insert the protector into the prepared humerus during the glenoid preparation.

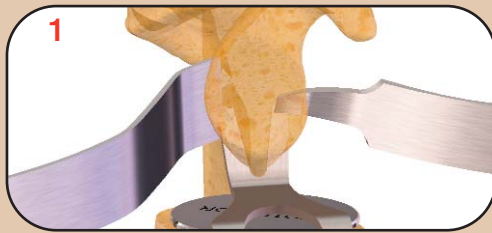

Glenoid exposure :

Expose the glenoid fully using the three types of retractors.

- Anterior retractor,
- Superior retractor,
- Inferior retractor.

Remove the glenoid labrum.

Remove any potential osteophytes to expose the full bone anatomy.

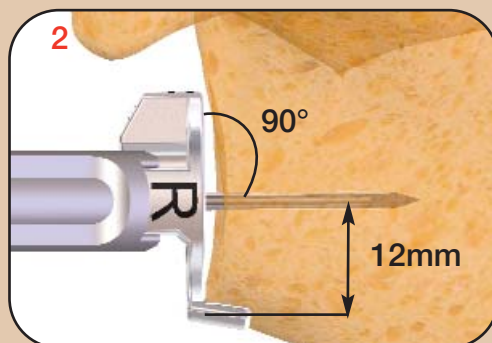

Placing the K-wire:

The three different positions for the guide are: Left (L), Right (R) for a deltopectoral approach and Superior lateral (S).

Position the K-wire guide on the inferior part of the glenoid to determine the correct height.

The K-wire is 12 mm above the lower edge, according to Kelly¹ and must be centered in the antero-posterior plane.

The K-wire guide orientation is important for the glenoid tilt and must be done at 90°-(see picture #2).

The glenospheres are tilted (lower lip) by 10°.

Positioning should be to fit the anatomy of the patient and planned according to the pre-operative X rays.

This element must be decided in pre-operative planning. By default, the base plate is perpendicular to the mid plane of the glenoid.

Insert the K-wire using a power tool.

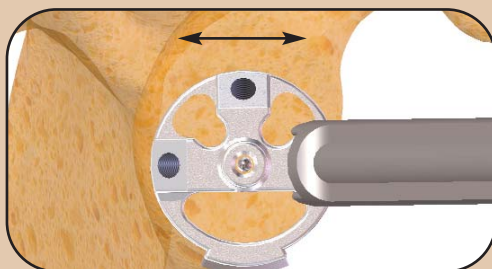

(1) Kelly JD, Humphrey CS, Norris TR. Optimizing glenosphere position and fixation in reverse shoulder arthroplasty, Part One: the twelve-mm rule. J Shoulder Elbow Surg 2008;17:589-94

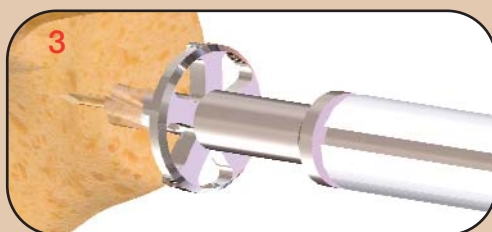

Glenoid reaming:

Drill and ream the glenoid using the K-wire as a guide.

Ream until the subchondral bone is reached.

This step can be done by power or by hand if the glenoid is porotic.

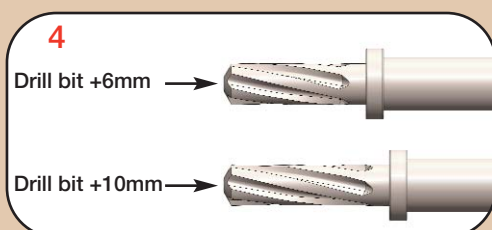

Extension post:

If bone graft is used between the glenoid baseplate and the native glenoid, the baseplate post can be extended by 6 or 10 mm as required. It is important to check that the tip of the extension is properly implanted in the native glenoid.

Drill the post again with the stop drill bit either +6 mm or +10 mm as required.

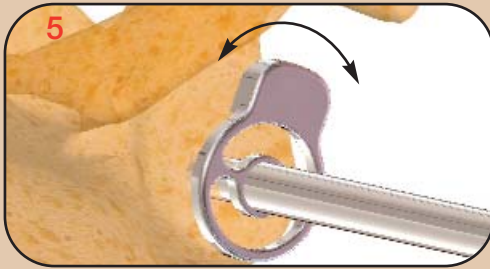

Glenoid clearance:

Remove the K-wire.

To avoid any interference between the glenosphere and the scapula, ream the glenoid using the Ø40 mm hand reamer.



Pay attention to avoid ovalizing the post hole.

360° clearance = successful impaction of the glenosphere.

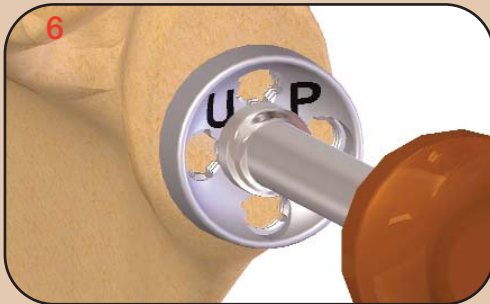

Positioning the baseplate: (Ø24 mm)

Connect the holder/impactor to the baseplate.

Impact the baseplate so that there is pressure on the whole surface. The impactor allows for the upper and lower holes to be placed so that a screw can be positioned in the base of the coracoid and in the pillar of the scapula.



The UP marking must be on top under the coracoid basis.



Length of screws (7 sizes from 20 to 50 mm) :

An adapted guide allows drilling and measuring the screws with the Ø 3.2 mm drill bit.

The length of the screws is measured directly.

The screw length is measured from under the head.

Two types of screws are available, locking or standard (compression).

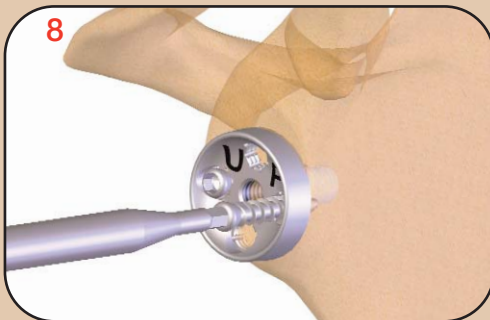

Fixation of the baseplate: (Ø24 mm)

Standard screws allow the baseplate to be lagged to the bone, and locking screws fix the mounting.

Each screw allows an angulation of +/-12° around the axial hole.

The upper hole is pre-oriented by 10° to optimize its positioning in the base of the coracoid.



Recommendations:

2 compression screws (std) for anterior and posterior holes.

2 locking screws for superior and inferior holes.



OPTION: SPOILER AND/ OR LOCKING

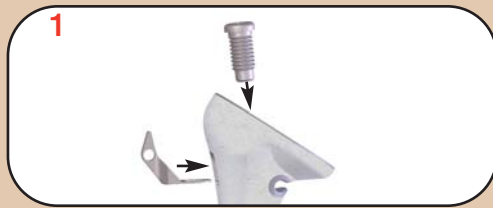

Fitting the spoiler (OPTION) :

If additional anti-rotational assurance is desired, addition of a spoiler to the system is available as an option. The spoiler is intended to penetrate the cancellous bone when the stem is inserted, and act as a fin to resist rotation of the stem.

After choosing the appropriate stem, insert the spoiler into the slot on the lateral side of the stem. Insert the hex screw through the top of the stem, passing it through the hole in the spoiler and engaging with the internal threads of the screw hole in the stem.



For locked stem (OPTION):

If additional anti micro-movement assurance is desired, addition of cortical screws to the system is available as an option.

Screw the aimer (jig) into the threaded hole of the stem.

Check if the pin is correctly located in its housing within the stem.

Tighten the screw of the mounting «implants + aimer (jig)».

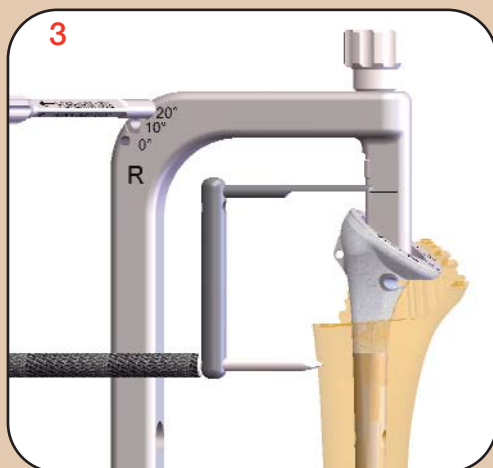
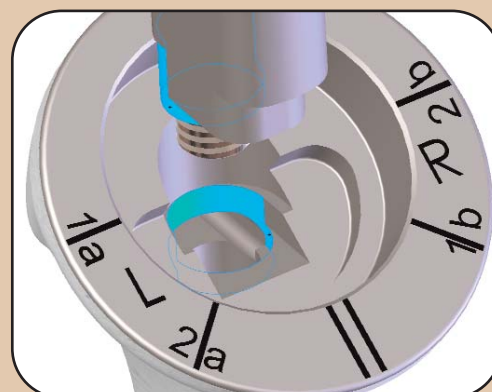

The retroversion is determined by screwing the rod into one of 3 positions (0, 10, 20°) and aligning it with the arm.

Use the Muraschosky² criteria to set the height of the implant.

(2) Murachowsky J et al. JSES 06; Torrens C et al. JSES 08; Hasan SA et al. Orthopedics 09



If the epiphysis and/or metaphysis is totally damaged, it is better to use a cemented stem so as not to have excessive weight bearing on the screws.

Proximal interlocking:

Carefully dissect the soft tissue using Halstead forceps.

Insert the Ø10 mm guide into the top hole of the aimer (jig), using the soft tissue protector, until contact is made with the cortex.

Insert the Ø4.5 mm guide into the Ø10 mm guide.

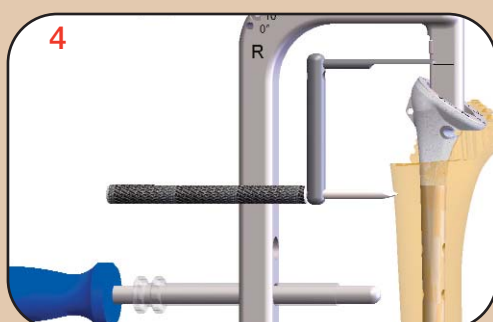

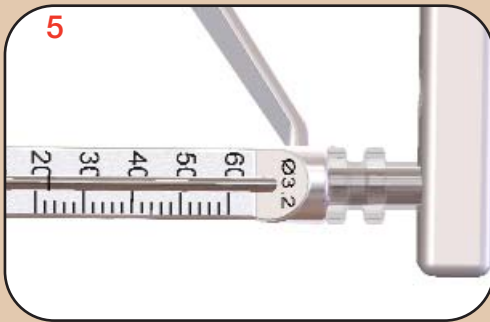

Screw lengths (10 sizes):

Drill through the first cortex using the marked drill bit.
 Stop at the second cortex, measure and use a screw size 4 mm longer, ie **L + 4 mm**.
 Drill through the second cortex.

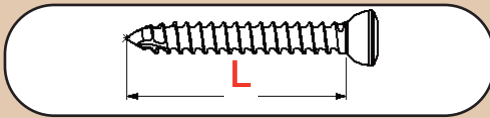

Screw length is measured from under the head.

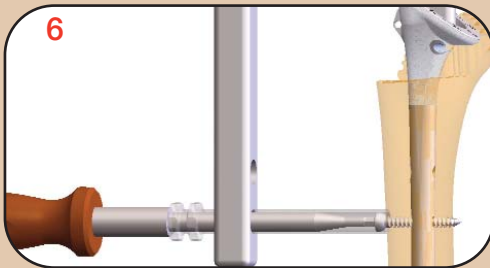

Distal interlocking:

Use the same method as proximal interlocking.

Remove aimer (jig) and replace the spoiler screw.

Secure the spoiler using the screw provided with the Hex 3.5 mm screwdriver through the top of the stem, passing through the hole in the spoiler and engaging with the internal threads of the screw hole in the stem.

Protect the stem and the humerus with a protector, by placing it in the stem during the glenoid preparation.

Fitting of Smartloop sutures:

- 2 traction loops (white)
- 2 plating loops (blue)

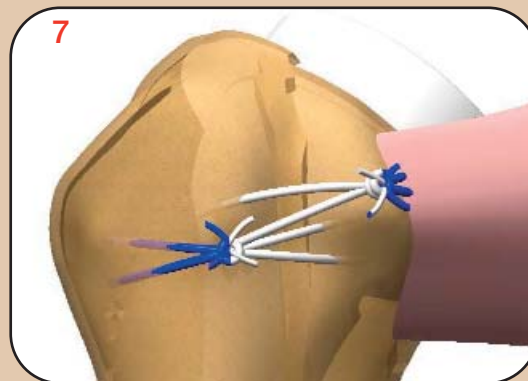



TRIAL IMPLANTS

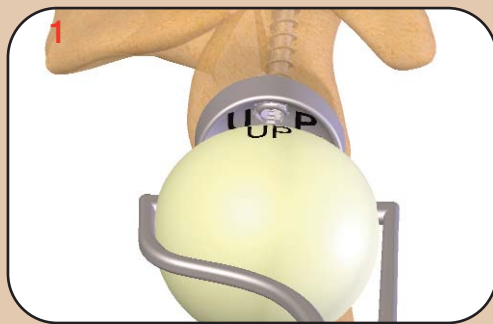

Glenosphere trial (10° tilt):

There are two diameters of glenospheres: Ø36 and 40 mm.

All glenospheres are centered or eccentric with or without a screw. The choice of glenosphere does not depend on the size of the humeral stem.

All glenospheres are tilted downwards by 10°.

Position the glenosphere with the special clamp allowing the humerus to be circumvented by the delto-pectoral approach.

The choice of the suitable glenoid implant depends on the stability of the shoulder:

Proceed with a trial reduction using a 36mm diameter glenosphere trial implant.

- If tension of the conjoint tendon is substantially decreased by palpation, change from the 36 to the 40 mm diameter trial implant.
 - Perform longitudinal traction holding the arm in neutral position trying to detect maximum separation of the trial prosthetic surface. If this maneuver causes inferior subluxation change from the 36 to the 40 mm diameter trial implant.
 - External rotation may demonstrate a slight gapping (2 to 3 mm) between the glenosphere and the articular surface. If the gap is increased, change from the 36 to the 40 mm diameter trial implant.
 - If external and internal rotation cause early contact between the metaphyseal bone and the scapular pillar with a tendency to sublux, change from the 36 to the 40 mm diameter trial implant.
 - Perform forced adduction of the arm with your fist in the axilla as a fulcrum. This is supposed to cause a slight opening of the joint gap (not more than 2 to 3 mm) without lateral dislocation, otherwise change from the 36 to the 40 mm diameter trial implant.
 - Finally, assess stability at 90° of abduction with the humerus in external, neutral and internal rotation.
- If on the other hand reduction with the 40 mm diameter trial implant is impossible or very difficult, you will need to use the 36 mm diameter trial implant.



Reversed cup trial:

The cup diameter matches the glenosphere diameter.

Three heights are available (+3, +6, +9 mm).

Choice of humeral cup:

The choice of humeral cup depends on the stability of the shoulder and the activity level of the patient:

The Mobility Cup is a good option for active patients with good to excellent stability and strength of the subscapularis and infraspinatus muscles. The Standard Cup should be considered in less active patients with instability due to rotator cuff insufficiency. The choice of the Standard Reversed Humeral Cup or the Standard Reversed Humeral Cup plus Humeral Spacer +09 mm is based on the height needed for the humeral side of the joint reconstruction. Most patients can achieve adequate humeral height with the +3 mm, +6 mm or +9 mm options available with the Reversed Humeral Cup. The choice of height depends on the location of the humeral cut, the stability of the reconstruction, the tension of the deltoid muscle (based on palpation) and the activity level of the patient. In rare cases with significant metaphyseal bone resection (e.g. revisions, tumor resections), additional humeral height may be desired. In these cases, the Humeral Spacer +09 mm may be used with the Standard Humeral Cup to provide an additional 9mm of height, resulting in humeral construct heights of +12 mm, +15 mm and +18 mm.



Take care to respect index marks on the stem and cup.

Test for stability and mobility. Trials are identical to final implants.

DEFINITIVE IMPLANTS



Handling of the definitive glenosphere:

Impacted glenosphere

Insert the glenosphere implant holder into the definitive implant. On the specially designed clamp, there are notches on the jaws which should be positioned to coincide with those on the middle of the glenosphere implant.



Handling of the definitive glenosphere w/screw:

Impacted glenosphere w/screw

Insert the 3.5mm hex screwdriver in the screw of the glenosphere.

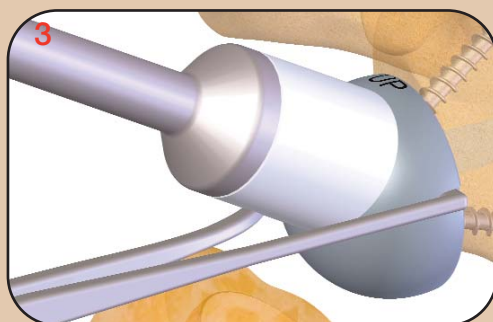

Fitting of the definitive implants:

Impacted glenosphere

When positioning the glenosphere, pay attention to the "UP" marking, if an eccentric glenosphere is used.

First introduce the guiding post, then the female taper of the glenosphere into the male taper of the baseplate.

Be sure to check that the baseplate is clean and free of any bone or tissue particles that could hinder impaction of the Morse taper.



Impact the glenosphere and check it before closure.

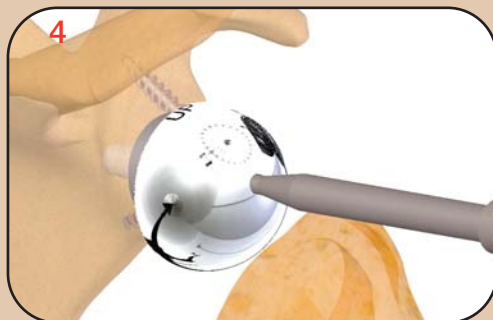

Fitting of the definitive implants:

Impacted glenosphere w/screw

Insert the glenosphere paying attention to the «UP» marking, if an eccentric glenosphere is used.

Introduce the screw of the glenosphere in the post of the baseplate.

Be sure to check that the baseplate is clean and free of any bone or tissue particles that could hinder impaction of the Morse taper.

- 1- Begin to screw the glenosphere w/screw.
- 2- Impact the glenosphere with the impactor.
- 3- Finish screwing



Do not impact the glenosphere with the screwdriver.



Index of the definitive reversed cup :

Find the index marks on both the definitive cup and the stem. Position the cup so that the index matches the index on the stem.

Insert the cup into the taper of the stem so that the indices of the cup and stem are correctly aligned.

Check that there is nothing impeding impaction of the cup and impact it.



If the neck of the scapula is short, it is recommended to use an offset glenosphere to reduce the risk of notching.

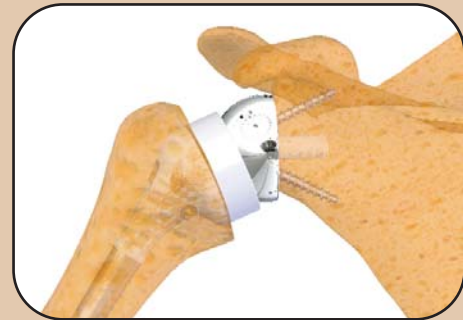

If the neck of the scapula is long, depending on the deltoid tension and the stability of the mounting, a centered glenosphere can be implanted.

REHABILITATION

Short-term immobilization (according to the surgeon's assessment) with mobilization in neutral rotation to promote recovery of external rotation.

Promote pool therapy and specialist rehabilitation, without counter-resistance work for six weeks, depending on the age and objectives noted in the "patient contract".

HEMI-PROSTHESIS ADAPTOR TECH.



Humeral cup removal:

Remove the cup by sliding a Powel's blade between the cup and the stem.



Fitting of the taper adapter:

Insert the male taper adapter into the female taper of the stem so that the index of the taper adapter and the stem are correctly aligned. Check to ensure that nothing is impeding the taper adapter and impact it.



Offset head trial:

Choose the best trial head fitting closest to the native anatomy. Record the details so that this position can be used for the definitive implant.



Fitting of the definitive implants:

Take the appropriate implant and insert it on the taper in the same position as the trial. Impact the head using the impactor.





IMPLANT REMOVAL

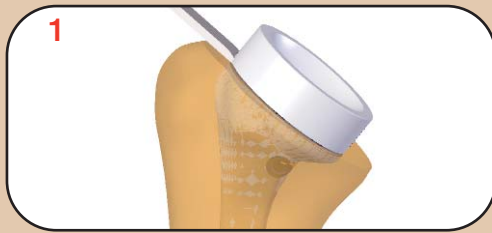

Humeral cup removal:

Remove the cup by sliding a Powels blade between the cup and the stem.

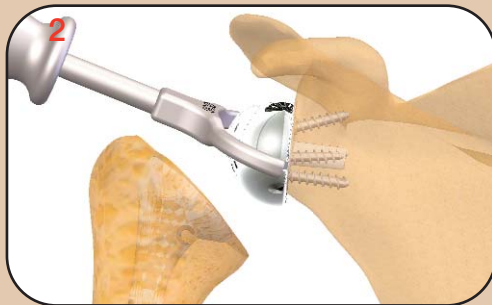

Glenosphere removal:

Unscrew the glenosphere screw with the 3.5 mm hex screwdriver. Screw the arch on the extractor with the corresponding \emptyset to remove the glenosphere.

Slide the spurs onto the internal face of the glenosphere to fit them in the designed notches.

Separate tapers with the sliding hammer.



Baseplate removal:

Unscrew the baseplate screws with the 3.5 mm hex screwdriver.



Screw the extractor into the baseplate post and remove it.

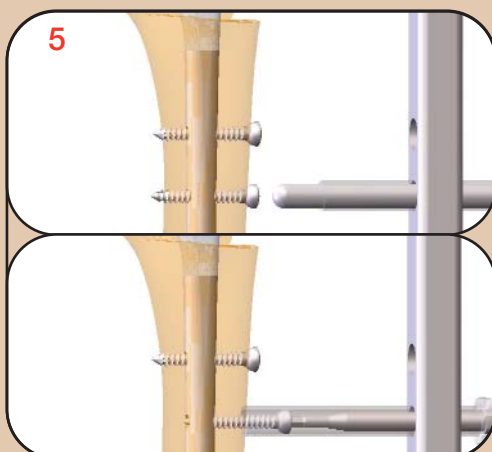

Extraction of the locking screws (OPTION):

After having carefully dissected the soft tissue using Halsted forceps, insert the \emptyset 10 mm guide into the top hole of the aimer until contact is made with the cortex using the soft-tissue holder.

Insert the screwdriver into the \emptyset 10 mm guide and remove the screw.

Repeat the procedure for the distal hole.



Extraction of the stem:

In order to remove the spoiler, the hex screw must be removed using a 3.5mm hex screwdriver. Then a stem extractor is threaded into the same hole used by the hex screw. The stem is backed out and then the spoiler can be slid out of the stem.

If the surgeon has difficulty removing a cementless stem used without screws and suspects that tissue growth into the empty screw holes is impeding removal of the stem, the aiming jig can be attached to the humeral stem and used as a drill guide to drill through the screw holes in the stem, removing any ingrown tissue.

If, after this step, removal of the stem is still difficult, the surgeon can make a vertical corticotomy and loosen the complete circumference of the stem from the cut bone.

